

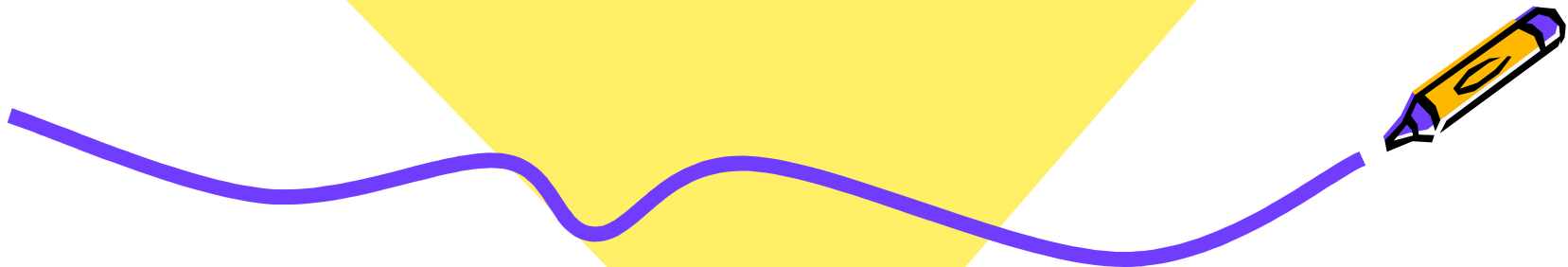

LUBE OIL SYSTEM

OF ALCO LOCO



# OBJECTIVE

- . INTRODUCTION
- . Purposes
- Function
- System components
- Block diagram of system
- Failure of loco due to short of lube oil
- Corrective Action
- Reducing the lube oil consumption

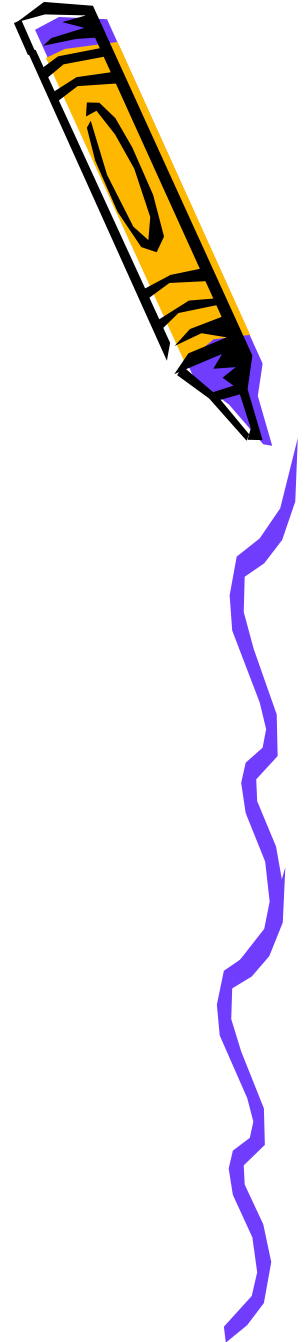

# INTRODUCTION

- The lubricating system in a diesel engine is of vital importance.
- The lubricating oil provides a film of soft slippery oil in between two frictional surfaces to reduce friction and wear.



# Purposes

It serves the following purposes.

- Cooling of bearing, pistons etc.
- Protection of metal surfaces from corrosion, rust, surface damages and wear.
- Keep the components clean and free from carbon deposits and prevent damage due to carbon deposits.



# • FUNCTION OF LUBE OIL SYSTEM

- The primarily function of the lube oil system is to circulate the lube oil in the system
  - At the correct quality
  - At the correct quantity and
  - At the correct pressure to various location of diesel engine.

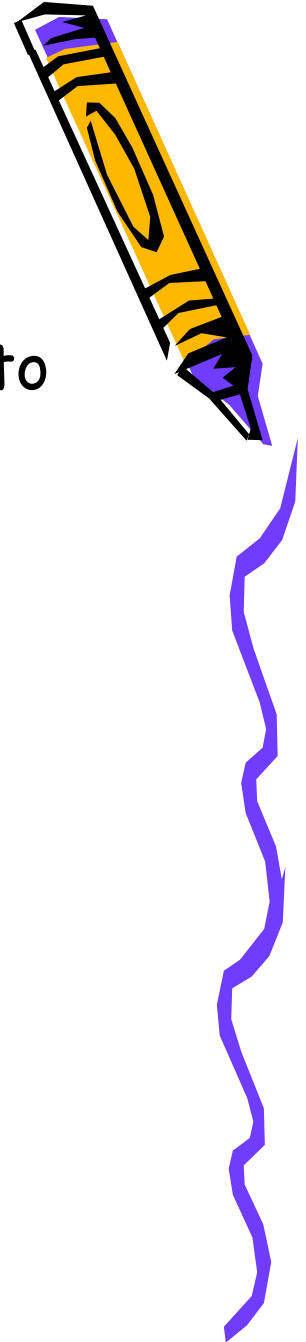

• The system essentially consists of the following components.

- 1 Gear type **lube oil pump** driven by the engine crankshaft.
2. Spring loaded **relief valve**, adjusted to 7.5 kg/cm<sup>2</sup>.
3. Lube oil **filter tank** accommodating eight nos. of filter elements
4. Differential **bypass valve** set at 1.4 kg/cm<sup>2</sup> differential pressure across the filter tank.
5. **Lube oil cooler**, which has a bunch of element tubes through which cooling water circulates and circulation of lube oil takes place around the tubes.
6. **Regulating valve**, which is a spring loaded valve adjusted to 5.5kg/cm<sup>2</sup>.
7. **Lube oil strainer**, which is a wire mesh type filter reusable after cleaning.
8. **Oil pressure switch (OPS)**, which is meant to automatically shut down the engine in case of a drop in lube oil pressure below 1.3 kg/cm<sup>2</sup>.
9. **Oil pressure gauge**, which indicates the main oil header pressure.
10. **Oil sump having capacity** 1260 lt. RR606 multigrade oil.

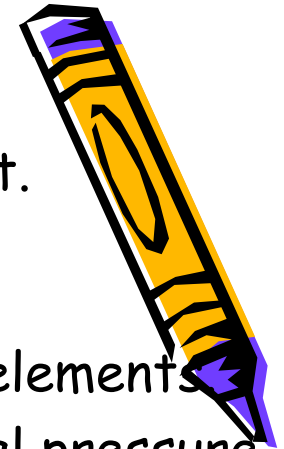

# LUBRICATING OIL SYSTEM

FIG. LOS-1

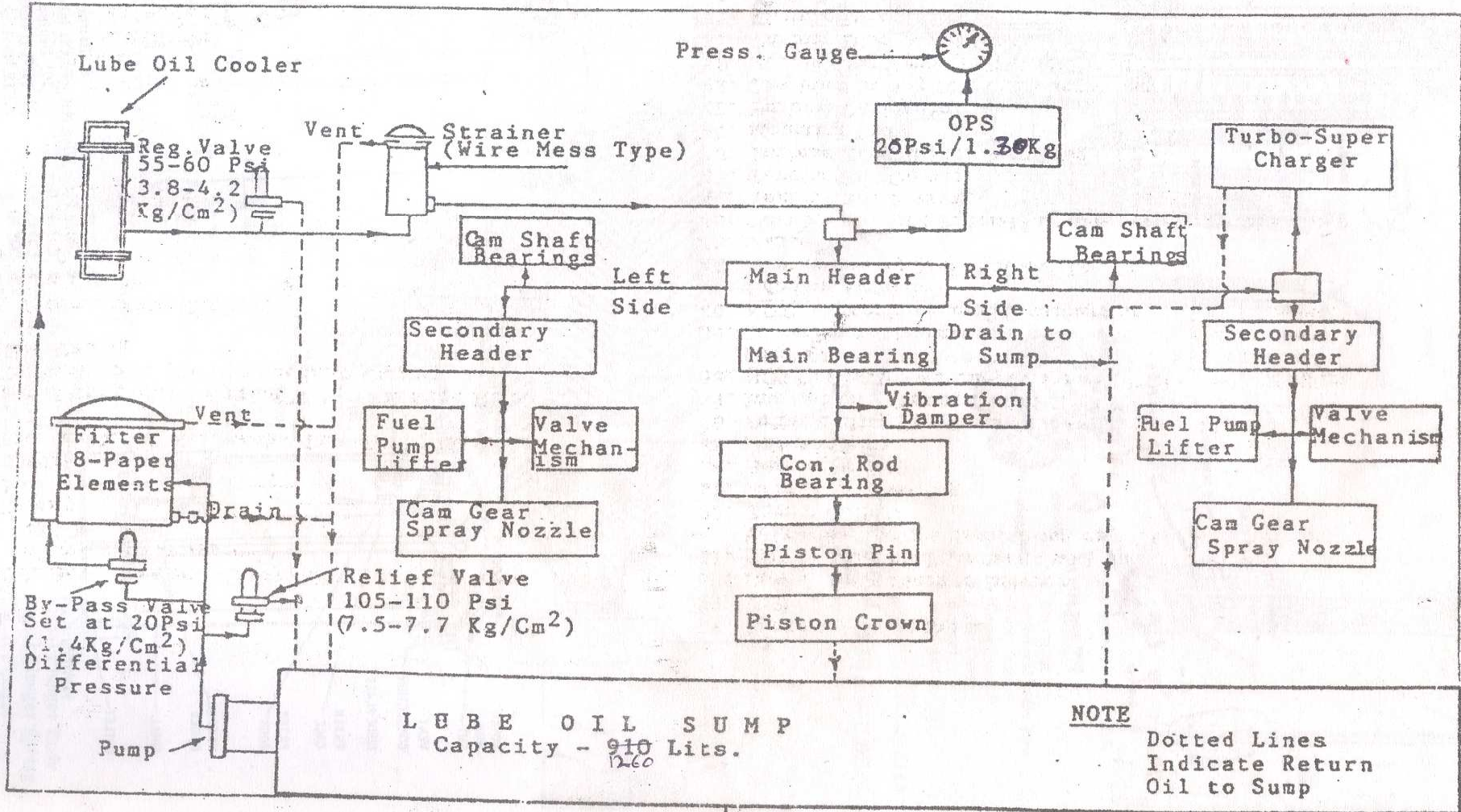

**NOTE**  
Dotted Lines  
Indicate Return  
Oil to Sump

Drain Plug



### Loco lube oil system

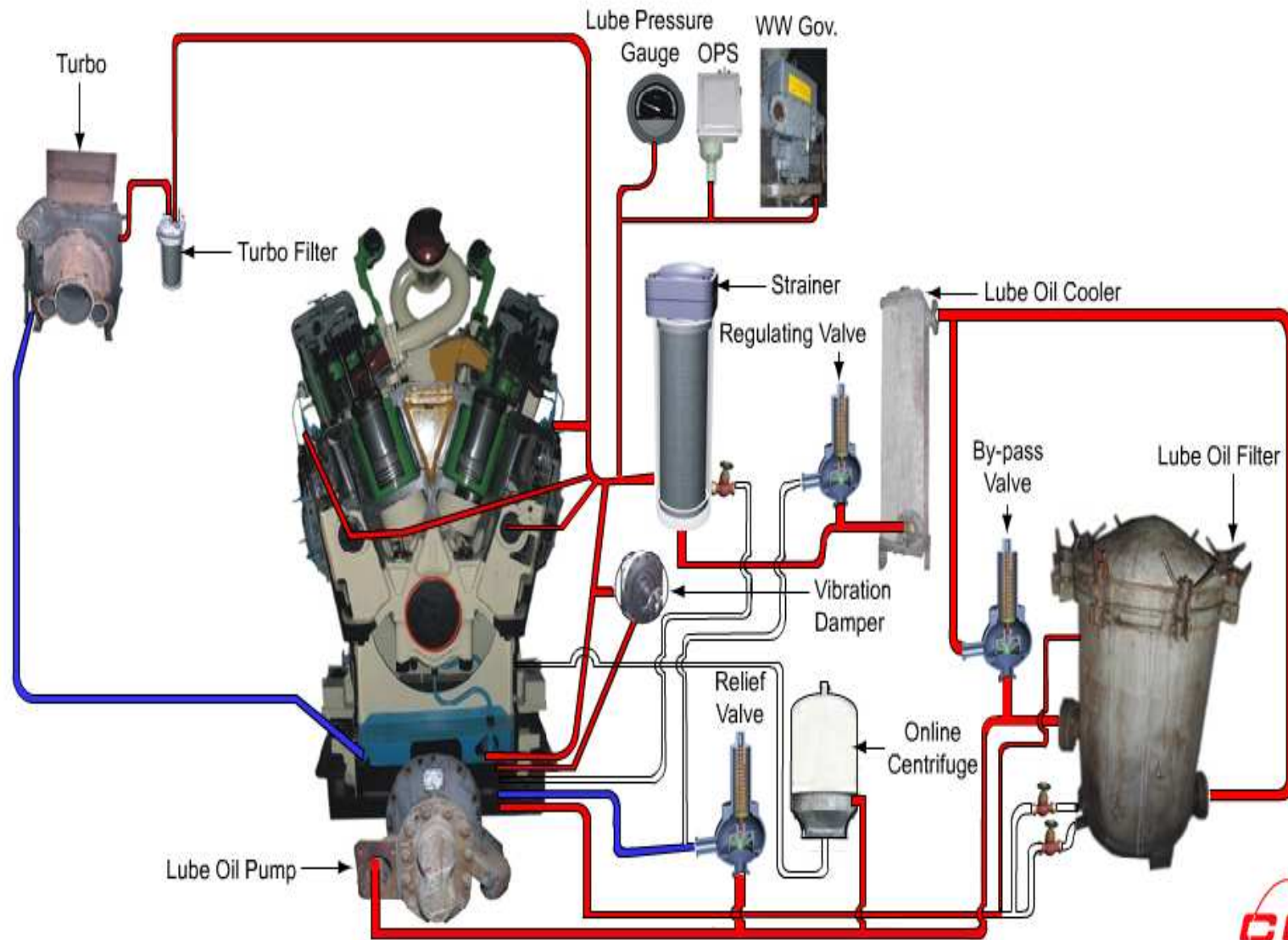

**Text** (Click on text button to see the text)

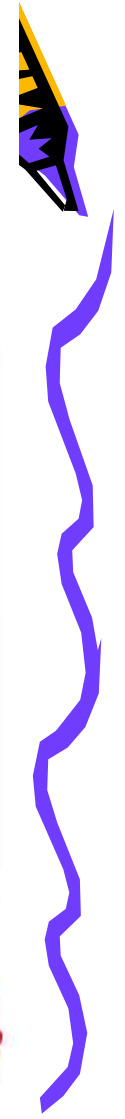
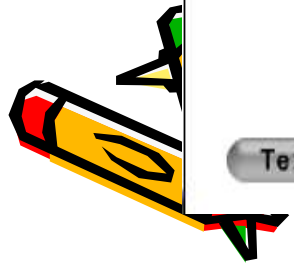



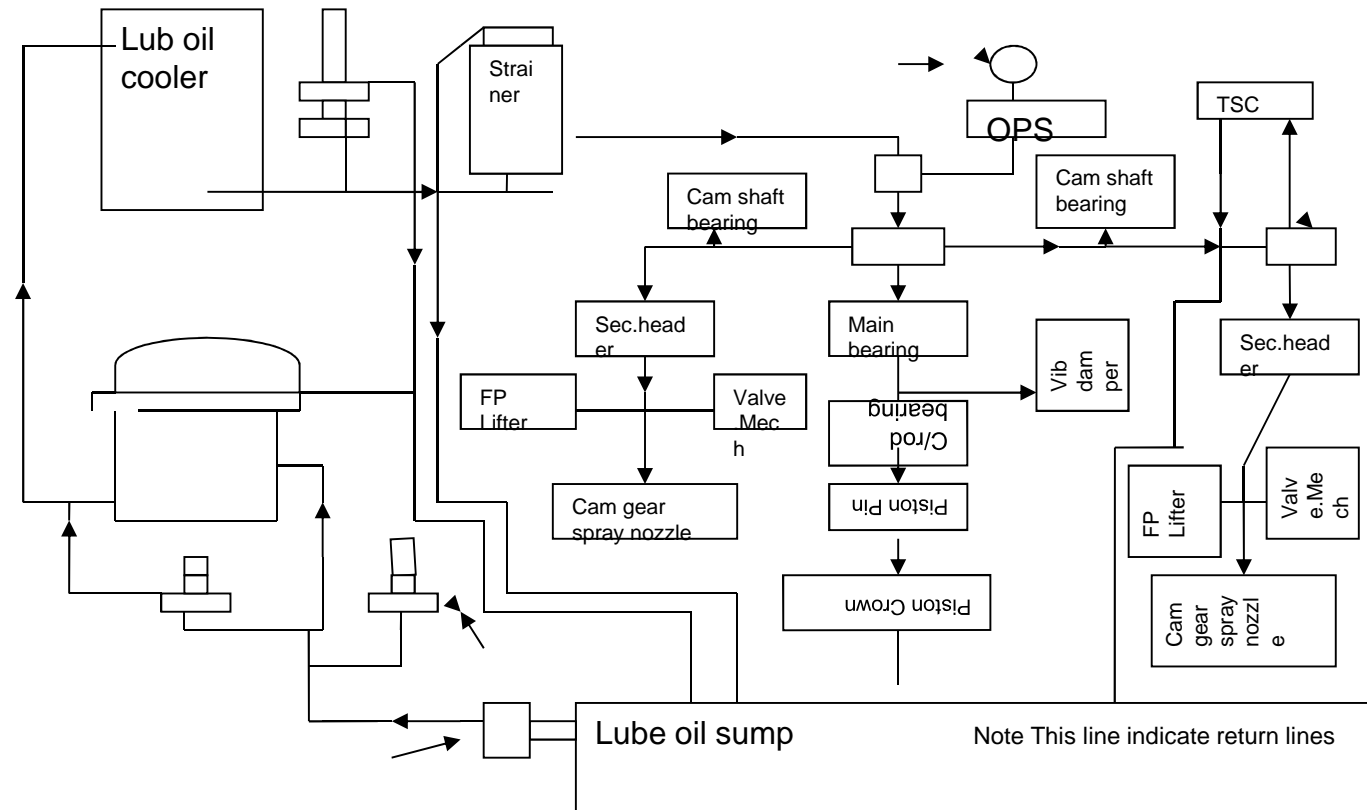

# External Leakage resulting in failure of loco due to short of lube oil.



The point of external leakage are as under:

- Tappet cover.
- Crank case cover
- Crank case explosion cover
- Push rod grommets
- Extension shaft oil seal

• Face joint of lube oil relief, regulating and By-pass valves



- From armoured, dressor or metallic joint
- Lube oil filter housing cover
- Lube oil filter housing drain cock and strainer  
drain cock
- Turbo oil filter housing due to working out of  
centre bolt
- Bursting of flexible pipes
- Lube oil gauge pipes and pipe to woodward  
governor
- Lube oil pump face joint or flange joint



2. Leakage from Lube oil cooler tubes, resulting in mixing of lube oil in water.

3. Defect lube oil pump

4. Excessive oil through from CCE motor exhaust pipe

5. Improper setting of relief, regulating or Bypass valve

6. Chocking of filter elements

Improper setting of oil pressure switch

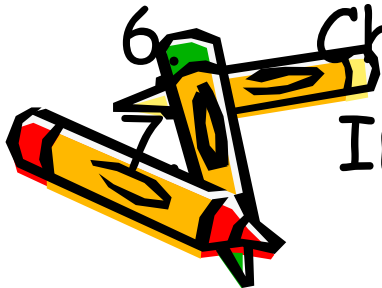

## Corrective Action

- Following corrective action is required during maintenance to avoid failures on lube oil system account:
- External Leakage
- Following attention should be paid to avoid leakage from armoured and drossor couplings:-
  - There should be no misalignment of pipes
  - Minimum gap between the two pipes should be ascertained. In case of excessive gap, suitable length of the pipe be welded to one of the pipes.
- Ensure proper clamping at adequate distance.



### 3. Lube oil filter housing:

- It must be ensured in every schedule that all fly nuts are intact.
- Tighten fly nuts cross wise at the time of replacement of lube oil filter housing 'O' ring.
- In case of pre mature failure of lube oil filter housing 'O' ring, check warpage in housing cover on surface plate.
- Check crack in the housing visually in every trip.
- Test filter housing at 10 kg/cm<sup>2</sup> during yearly schedule.

Replaced defective drain cock.

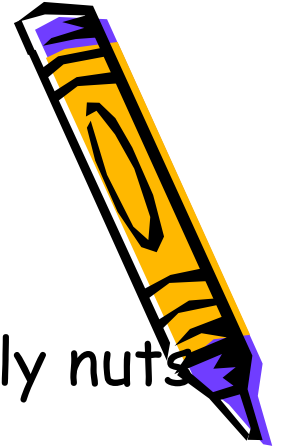

- Following additional points will help in **reducing the lube oil consumption** of the locomotive.
- Heavy leakage of lube oil is also noticed from OST.
- It is essential that drain pipe of OST housing to sump is cleaned, so that oil can go back in to the sump freely without any obstruction.
- In case of excess oil through from the engine exhaust due to weak power pack, attend locos on programmed basis.
- Ensure maintaining adequate clearances on turbine and lowered end seals of ALCO TSC.

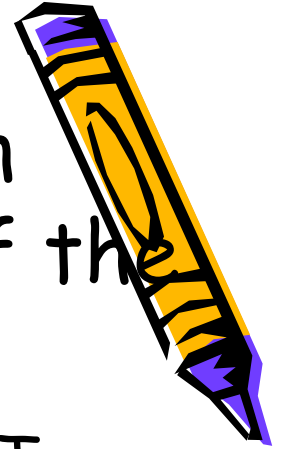

- Ensure fitment of piston rings at 180 degree to each other avoiding the gudgeon pin side.
- Cylinder liners having internal dia more than 228.70 mm should not be reused.
- Check valve guide internal bore dia during overhauling of cylinder heads.

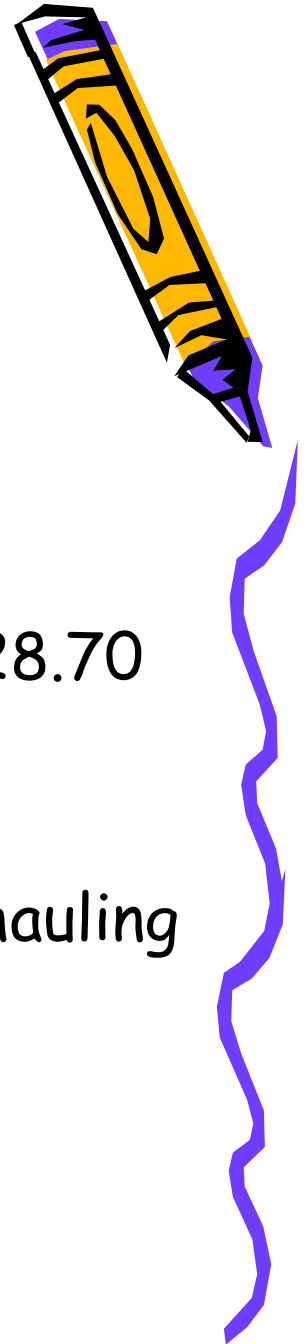



- Check engine sump vacuum on load box on at 8th notch. It should be minimum 0.9" of water.
- Positive pressure or less vacuum will increased LOC.
- Avoid water leakage in lube oil by providing proper quality 'O' rings on the liners .
- Check pitting/corrosion of the mating surfaces of the liner or the block.
- If water contamination is more than 0.25%, it will required lube oil change.
- Every filter change would amount to loss of some lube oil. It the filter life is less either due to poor filter material or due to poor engine condition, it will have adverse affect on lube oil consumption.



- No loco should leave the shed without X-head dowel.
- Check lube oil cooler for leakages from welded joints/rivets in every trip. If lube oil is mixed in water, change the cooler.
- Ensure hydraulic testing of lube oil cooler during yearly schedule.
- Check crack in turbo lube oil filter housing in every schedule.
- Replace all flexible pipes as per schedule.
- Pay adequate attention to lube oil gauge pipes and pipe to woodward governor.



- Ensure proper setting of OPS in specified schedules.
- Test relief, regulating and By-pass valves during HY schedules.
- Ensure quality of lube oil through spectrographic analysis.
- Checks its viscosity, PH value and contamination regularly.

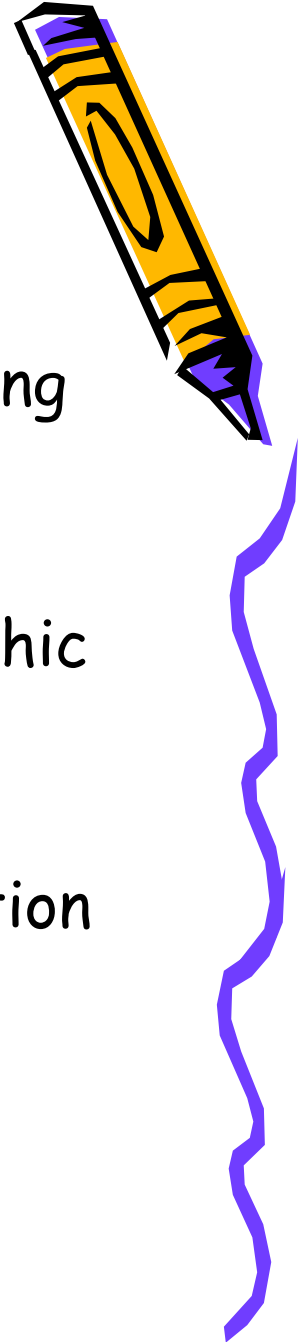



THANKS

